

PARTY TENT MEGA TERZ 8M



Clear-span width

800 cm

side height

229 cm

ridge height

374 cm

Highest point

524 cm

Roof pitch

20°

Bay distance

300 cm

Gable uprights

1 gable upright (per end)

Longest component

430 cm

Minimum tent length

As shown

Maximum tent length

No limit

Main profile

81 x 48 x 3mm - optional 94 x 48 x 3mm

Eave / corner connection

Internal eave insert

Max. allowed wind speed to DIN

50 mph windloading

0.3 kN/m²

Extension / lean-to options

½ hexagonal at gable end

With Mega tents 6m and 8m

Extension

Flooring options

Aluminium cassettefloor with plywood or full aluminiumboards

Cover

RÖDER No. 1: PVC-coated polyester textile, flame retardant to DIN 4102 B1, M2

Note

All Mega variations fit 6m, 8m and 9m standard party tents

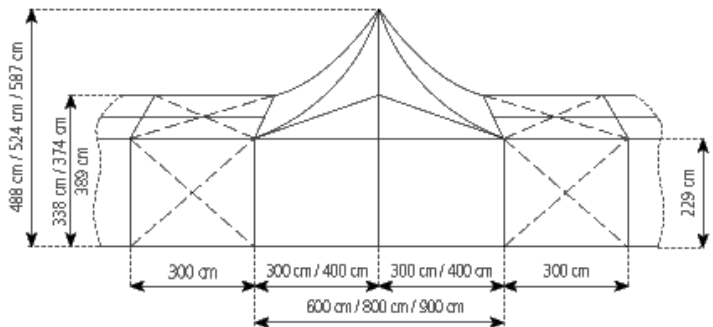
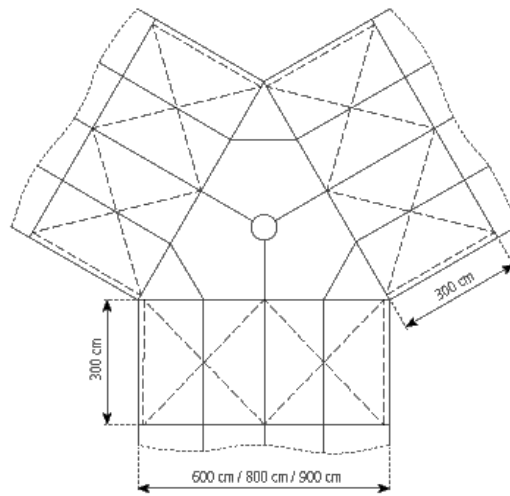

23.09.2008, www.r-zs.de/en/27

RÖDER Zelt- und Veranstaltungsservice GmbH
 63654 Büdingen Fon: +49 06049 700-0
 Verkauf: Am Lautenstein Fax: +49 06049 700-339
 Vermietung: An den Ellern Fon: +49 06049 700-309
 HRB 3261, Friedberg UST.-IdNr.: DE 112607812

Geschäftsführer:
 Rüdiger Blasius
 Jens Brüggemann
 St.-Nr.: 20 242 70249

Bank:
 WGZ Bank eG
 KBC Bank DTLD AG
 Fortis Bank
 Duns-Nr.: 32-239-9494

IBAN BLZ Konto
 DE73 400 600 00 0000 772 633
 DE86 500 203 00 0000 295 086
 DE15 370 106 00 1102 421 161
 info@r-zs.com

SWIFT/BIC
 GENO DE MS
 BANV DE HB 500
 GEBADE 33
 www.r-zs.com